

CMS-2

14 m / Harbour / River Type Workboat



GENERAL DATA

IMO	-----
Call Sign	4JOG
Built	2010, BESIKTAS SHIPYARD, ISTANBUL, TUKEY
Basic functions	Tug Vessel
Classification	KM ⚓ R3
Flag	Azerbaijan

DIMENSIONS

Length o.a.	14.95 m
Beam o.a.	8.00 m
Depth at sides	2.45 m
Max draft	1.5 m
Gross tonnage	73 T
Net tonnage	20 T
Max .dead weight	127 T

TANK CAPACITIES

Fuel oil	34.000 l
Fresh water	15.000 l
Black water	2.880 l
Oily bilge	750 l

PERFORMANCES (APPROX.)

Speed	7 knots
-------	---------

PROPULSION SYSTEM

Main engines	2xVOLVO PENTA 335.56kw@1800rpm
Propellers	2xPropeller

AUXILIARY EQUIPMENT

Generators	CAT C4.4 Gen-set, .38 ekW
Voltage	380 W
Frequency	50 Hz

DECK LAY-OUT

Anchor	Super High Holding Power 136.8 kgs
Anchor chain	13.5 m x Ø 16 mm, Grade 2 stud chain, breaking strength 151 kN
Anchor winch	HHAW 15-16, reel type, electro hydraulic
Deck crane	max 5.140 kg - 2.0 m; boom 945 kg - 9.95 m
Deck area	56 m ²
Deck cargo	61 ton / 3 ton/m ²

ACCOMMODATION

1 cabin	4 bed
---------	-------

PEOPLE ON BOARD

Crew	3 persons
------	-----------

NAVIGATIONAL EQUIPMENT

Radar Furuno	1
Eco sounder	1
Magnetic compass	1
VHF radio	1
GPS	1
Endurance	7 days

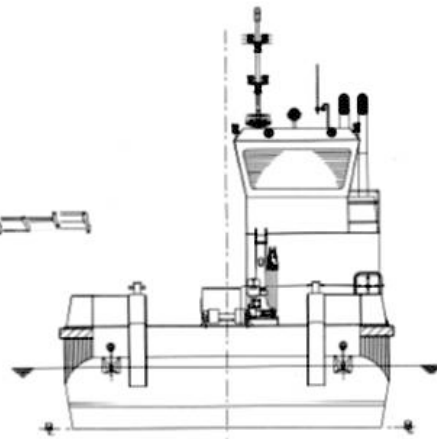
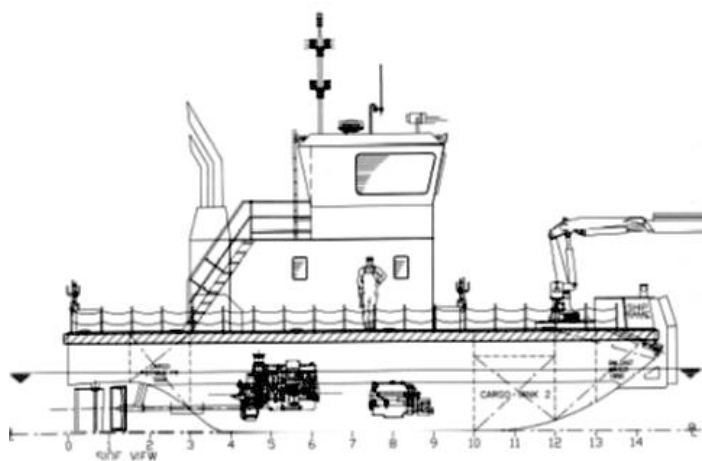

FRONT VIEW

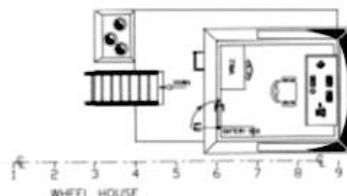
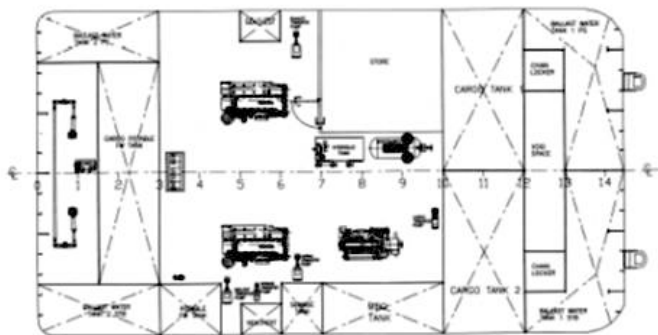

WHEEL HOUSE

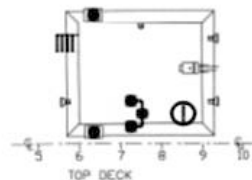

TOP DECK

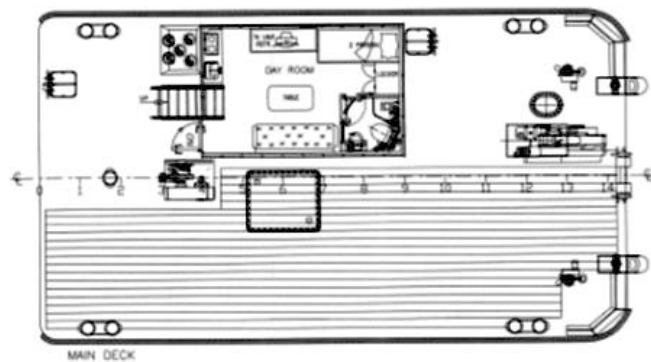

MAIN DECK

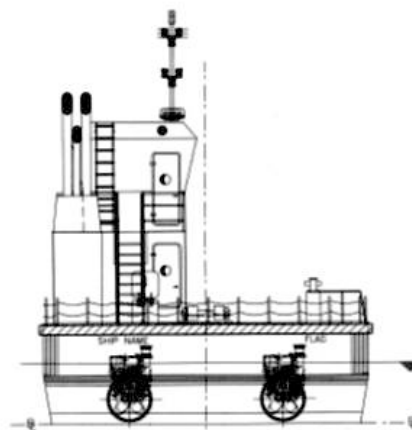

AFT VIEW



38 A, N.Aliyev street
 AZ1025 Baku, Azerbaijan
 T: +994 12 4641531 / 32
 E: info@caspmarine.com
 W: www.caspmarine.com